

Nr.	Art.-Nr.:	∅ x Länge/ ∅ x length	Menge/ qty.
1	572132500501-3	1 x 32 x 1070 mm, 1 x 28 x 910 mm	1
2	572132500502-3	1 x 32 x 1070 mm, 1 x 28 x 910 mm	1
3	572132500503-4	2 x 32 x 120 mm, 1 x 32 x 630 mm	1
4	572132086020-1	32 x 860 mm	3
5	572132107020	32 x 1070 mm	3
6	572128107010-1	28 x 1070 mm	3
7	572128107016-1	28 x 1070 mm	3
8	572132107020-1	32 x 1070 mm	3
9	572132086020-1	32 x 860 mm	2
10	572132056020-1	32 x 560 mm, nur bei Gr. 15-17	2

Zubehör/accessory	Menge/qty.
	3
	6
	11
	3

Zubehör/accessory	Menge/qty.
	1



CC 32 Grundgerüst

Stahl 32 x 1,5/ 28 x 1 mm

Güsto 2000

Art.-Nr.: 570432113501-10

SIGNATURE: 13.05.15, Schw.

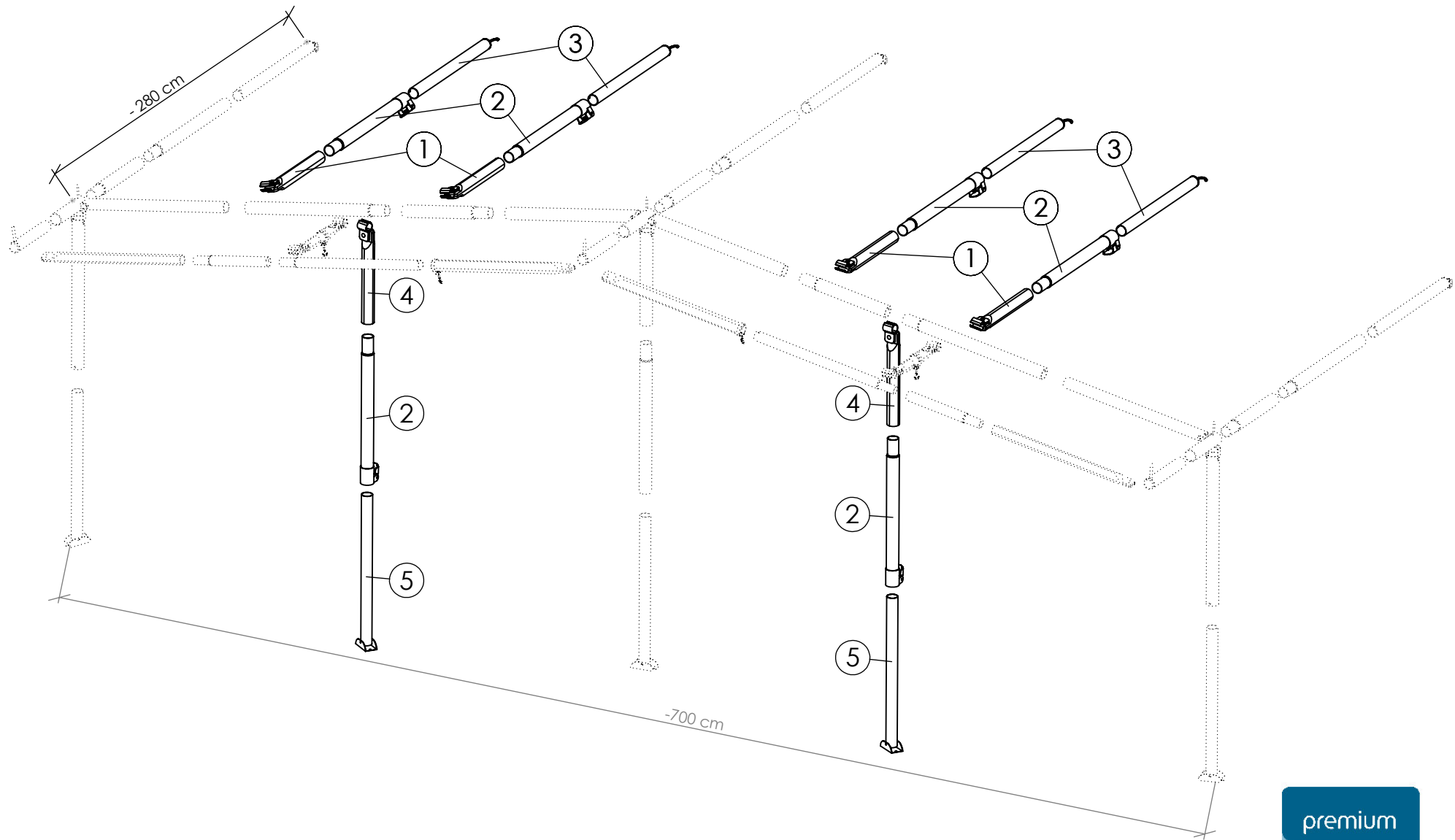





CC Erg.-Satz Gr. 05-17

Stahl 32 x 1,5 / 28 x 1 mm

Güsto 2001

Art.-Nr: 570432500500

SIGNATURE: 18.12.12, Schw.



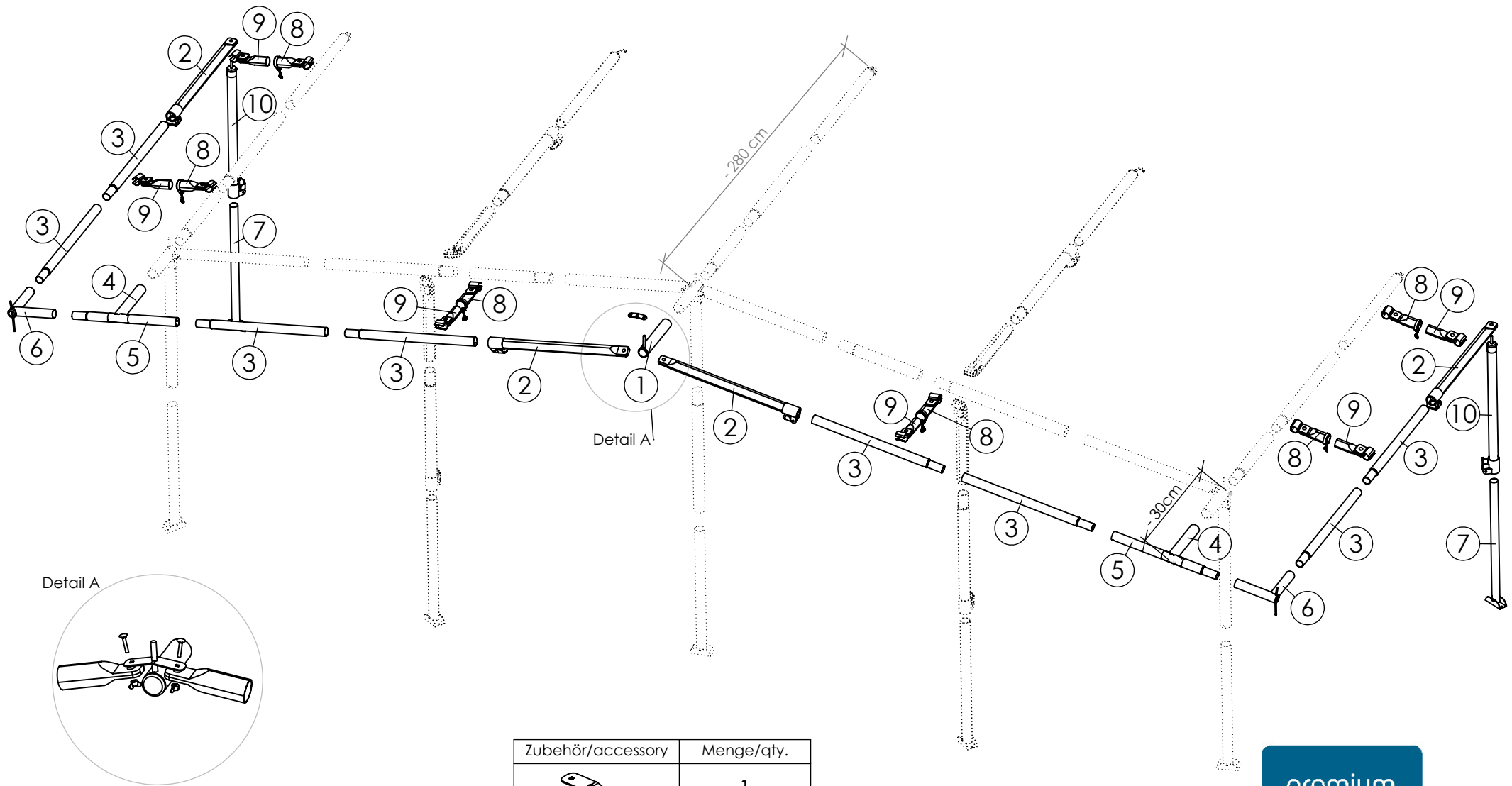

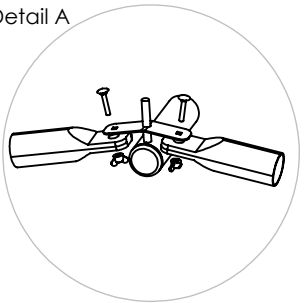

Nr.	Art.-Nr.:	∅ x Länge, ∅ x length	Menge/qty.	Zubehör/accessory	Menge/qty.
1	572132080024	32 x 800 mm	4		4
2	572132107020-1	32 x 1070 mm	6		8
3	572128107010-1	28 x 1070 mm	4		6
4	572132067024	32 x 670 mm	2		6
5	572128107016-1	28 x 1070 mm	2		6



Detail A



Nr.	Art.-Nr.:	∅ x Länge, ∅ x length	Menge/qty.
1	572128020032	28 x 200 mm	1
2	572128107026	28 x 1070 mm	4
3	572125107020-1	25 x 1070 mm	8
4	572128600040	28 x 200 mm, 28 x 60 mm	2
5	572125056020-1	25 x 560 mm	2
6	572125504011	2 x 25 x 200 mm	2
7	572125107012-BF	25 x 1070 mm	2
8	572122016026	22 x 160 mm	6
9	572119016024	19 x 160 mm	6
10	572128107010-2	28 x 1070 mm	2

Zubehör/accessory	Menge/qty.
	1
	2
 ∅ 32 mm	6
 ∅ 25/28 mm	6
 ∅ 22 mm	6
 ∅ 28/25 mm	6



CC Erg.-Satz Top

Stahl 28 x 1/ 25 x 1 mm

Güsto 2003

Art.-Nr.: 570432500002

SIGNATURE: 18.12.12, Schw.